

**JBL**

PROFESSIONAL

# MP410

 10 Inch  
Two-Way  
Speaker**M**PRO

## Professional Series

### Key Features:

- ▶ Laminar Flow Baffle™ design reduces distortion and diffraction effects by providing smooth, rounded surfaces. The single piece baffle is constructed of SMC (sheet molding compound), a durable, cross-linked thermo-plastic also used in automotive body parts.
- ▶ JBL 127H-4 10", woofer with 2", edge-wound voice-coil. Surround design optimized for maximum excursion and low distortion using FEA (finite element analysis) modeling.
- ▶ JBL 2412 compression driver with pure titanium diaphragm and ferro-fluid cooling for improved smoothness and thermal power handling.
- ▶ Enclosure constructed of 18 mm plywood and coated with JBL's exclusive DuraFlex™ - a rugged, advanced, poly-urea finish.
- ▶ 70° x 70° horn designed for even coverage and smooth response on and off axis.
- ▶ Input panel includes dual Neutrik® Speakon® NL-4 input connectors.
- ▶ Precision engineered crossover for optimal power response and performance in the critical mid-range region.
- ▶ SonicGuard™ protects high-frequency driver from excess power without interrupting the performance.
- ▶ Attractive 16 gauge, hexagon perforated, steel grill protects components from damage.
- ▶ 35 mm pole mount receptacle.

The MPro MP410 is a compact, portable, ten inch, two-way speaker system. The Laminar Flow Baffle reduces diffraction effects and



distortion resulting from turbulence. The horn design with its large mouth delivers smooth, natural reproduction - especially in the critical mid-range. A 16 gauge, steel grill protects the ten inch JBL woofer. Designed for portable applications in live performance, music playback, and reinforcement of speech, the MP410 will deliver excellent performance by itself or as a satellite over subwoofers such as the MP418S and MP418SP.

### Preliminary Specifications:

System Type:	10", 2-way, bass-reflex
Frequency Range (-10 dB) <sup>1</sup> :	50 Hz - 20 kHz
Frequency Response (±3 dB) <sup>1</sup> :	62 Hz - 14 kHz
Sensitivity (1w/1m):	94 dB SPL
Nominal Impedance:	8 ohms
Maximum SPL:	125 dB
Power Capacity <sup>2</sup> :	300 watts
Peak Power Capacity <sup>2</sup> :	1,200 watts
Nominal Dispersion:	70° x 70°
Dimensions (H x W x D):	508 mm x 338.4 mm x 299.7 mm (20.0 in x 13.3 in x 11.8 in)
Net Weight:	15.4 kg (34 lbs.)
LF Driver:	1 x JBL 127H-4
HF Driver:	1 x JBL 2412
Input Connectors:	Neutrik® Speakon® NL-4 (x2), parallel
Enclosure Construction:	DuraFlex coated, 18 mm plywood. One piece SMC (sheet molding compound) baffle with integral horn and ports. Top-mounted steel carrying handle. 35 mm pole mount socket.

<sup>1</sup> Half space (2π) conditions

<sup>2</sup> "Power Capacity" and "Peak Power Capacity" ratings are based on the average and peak power handling capacity of product samples subjected to a 100 hour power test of the system design using IEC filtered random noise with a crest factor of 6 dB

JBL continually engages in research related to product improvement. New materials, production methods and design refinements are introduced into existing products without notice as a routine expression of that philosophy. For this reason, any current JBL product may differ in some respect from its published description, but will always equal or exceed the original design specifications unless otherwise stated.

*CCI Solutions*  
be seen. be heard.

For more information or to order call

**1-800-426-8664** or visit [www.ccisolutions.com](http://www.ccisolutions.com)

# ▶ MPro MP410 10 Inch Two-Way Portable Sound Reinforcement Speaker

## Frequency Response:

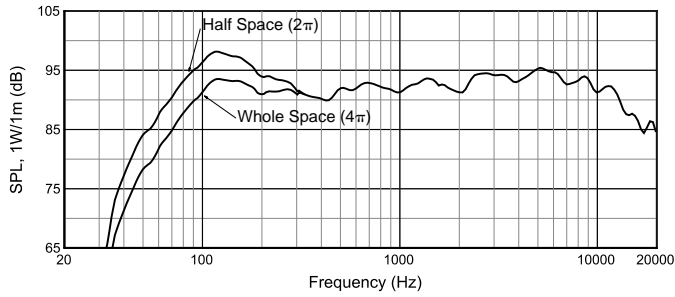

## Block Diagram:

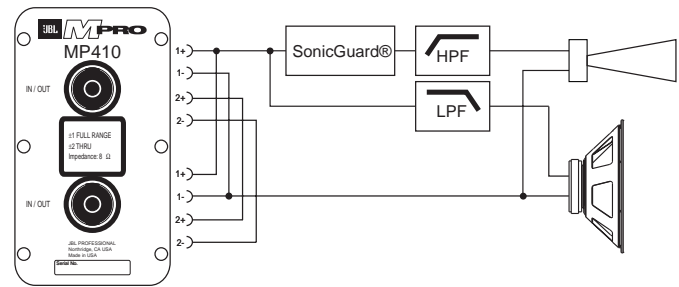

## Beamwidth:

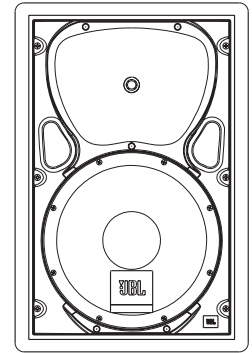
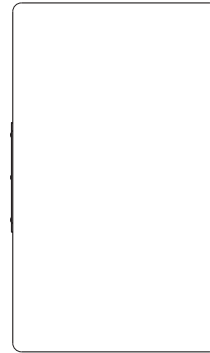
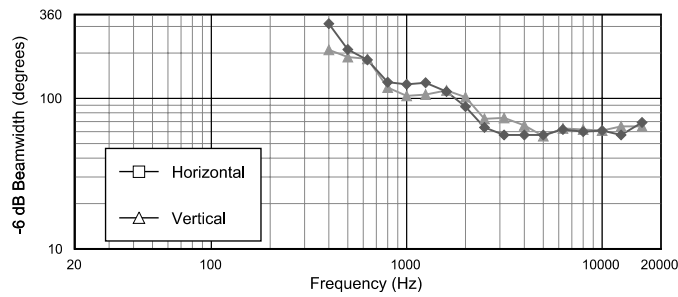

## Directivity Index:

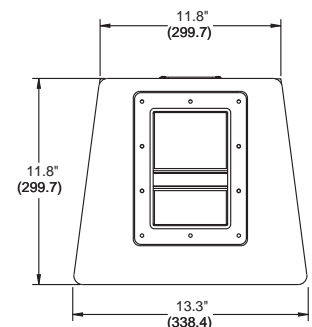
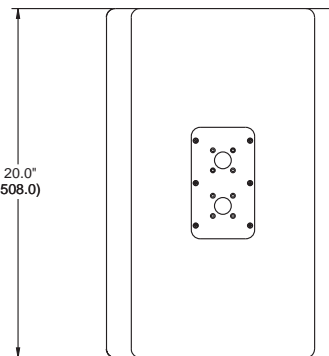
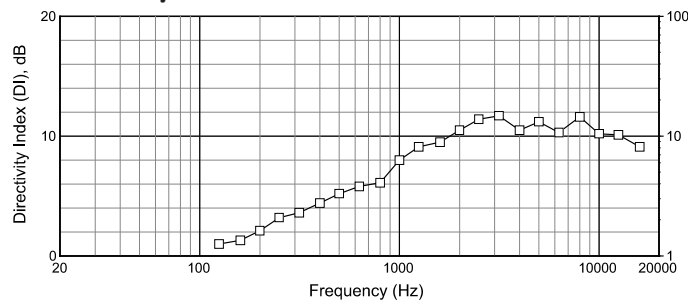

For more information or to order call **1-800-426-8664** or visit **www.ccisolutions.com**